

FLANGE HEATERS

immersion heaters

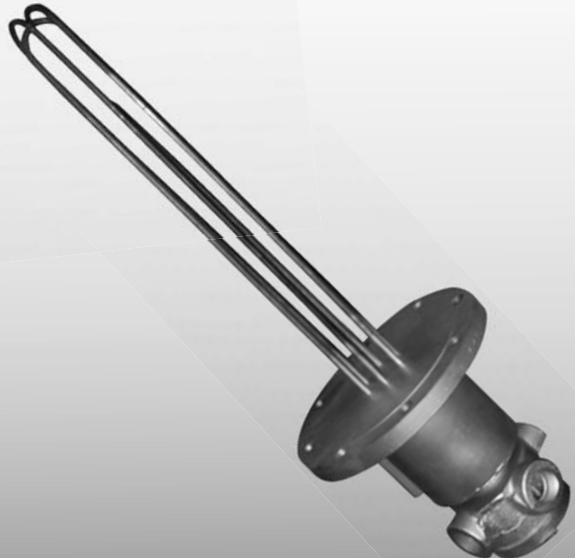
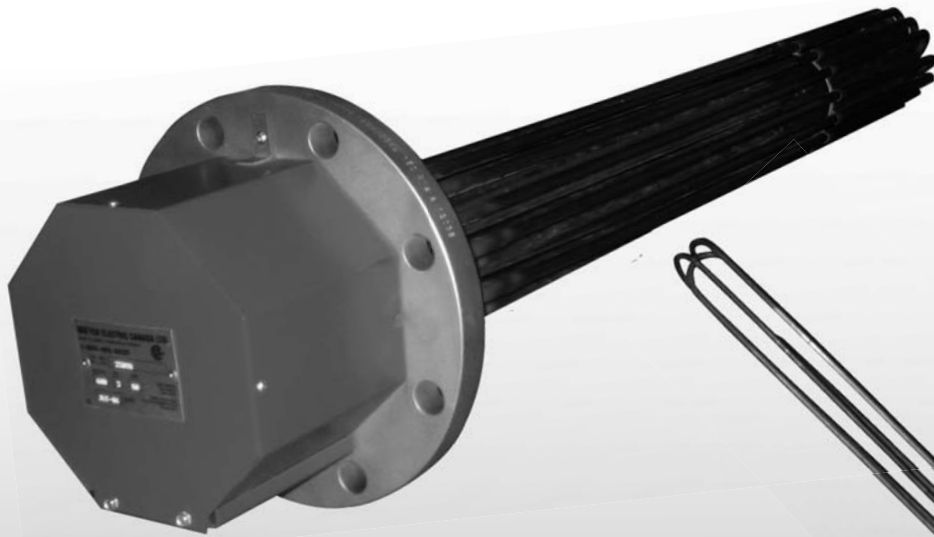

WATTCOTM

OVERVIEW

WATTCO™ flange heaters are made using hairpin or bugle type tubular elements using incoloy® sheathed elements that are welded or silver-brazed into a pipe or steel flange. Perfectly designed to be mounted in tanks and pressurized vessels, WATTCO™ flange heaters are used for heating liquid mediums or other specific types of liquids, and for heating gases (water, oil, heat transfer fluid, and corrosive solutions).

BENEFITS

- Easy to install
- Easy to maintain
- Perfect for higher kilowatt output applications
- Appropriate heater size provided for the application and fit
- Designed and built for safety



FEATURES

KEY FEATURES

- Standard heaters: ½" to 42" sizes.
- 0.260"; 0.315"; 0.375"; 0.430" or 0.475"; 0.625" diameter copper, steel, stainless steel.
- 150lb or 300lb forged steel flange
- Incoloy®, Inconel®, stainless steel, copper or titanium elements.
- Available explosion and/or moisture resistant terminal enclosures upon request.
- Available special sizes, wattages, and materials upon request.
- Heating units are custom-designed to meet your specifications.

FACTORS

Please consider the following factors in order to select the proper flange heater:

- Flange size and pressures
- Heating element watt density
- Length of your tank
- Sheath material (corrosive or non corrosive)
 - o Temperature of the corrodent
 - o Degree of aeration of exposed corrodent
 - o Velocity of the corrodent

The following sections will help you select the best WATTCO™ flange heater that will meet the requirements of your application. Please call us at 1.800.4WATTCO (1.800.492.8826) if you need any further assistance.

SELECTING YOUR WATTCO™ FLANGE HEATER

GENERAL RECOMMENDATIONS - FLANGE HEATERS - 2 1/2" 3" 4" 5" 6" 8" 10" 12" 14"

APPLICATIONS	SHEATH MATERIAL	FLANGE MATERIAL	HEATER TYPE
Clean water, Freeze protection, Hot water storage, Boiler and water heaters, Cooling towers, Solutions not corrosive to copper	Copper	Steel	FLC
Hot water , Steam boilers, Mildly corrosive solutions (in rinse tanks, spray washers)	Incoloy®	Steel	FLI
Oils, Gases, Mildly corrosive liquids, Stagnant or heavy oils, High temperature, low flow gas heating	Steel	Steel	FLO
Process water, Soap and detergent solutions, Soluble cutting oils, Demineralized or deionized water	Stainless	Steel	FLI
Mildly corrosive solutions	Stainless	Stainless	FLI
Severe corrosive solutions, Demineralized water	Incoloy®	Stainless	FLI
Light oil, Medium oil	Steel	Steel	FLO
Food equipment, Food equipment with cutout	Incoloy®	Stainless	FLI

Incoloy® and Inconel® are registered trademarks of Inco Alloys International

FLANGE HEATERS

immersion heaters

2 1/2" FLANGE HEATERS

Refer to **PAGE 2.1** for the **GENERAL RECOMMENDATIONS**

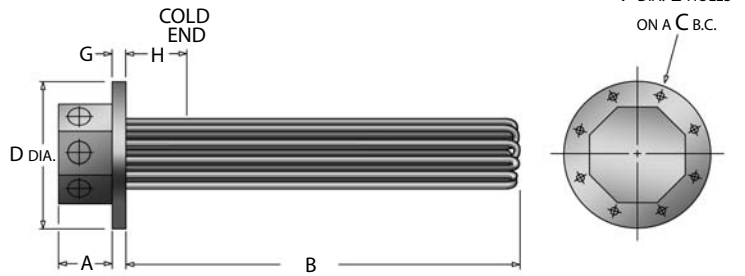

Terminal Boxes Available

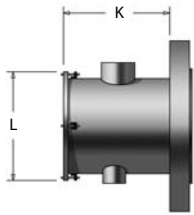

Moisture resistant Terminal Box

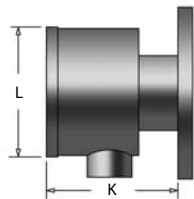

Explosion resistant Terminal Box

HEATER DIMENSION IN INCHES								
FLANGE SIZE	FLANGE RATING	A	C	D	E	F	G	H
2 1/2"	150 lb.	2 7/8	5 1/2	7	4	3/4	7/8	5 1/2
	300 lb.	2 7/8	5 7/8	7 1/2	8	7/8	1	5 1/2

TABLE 1
2 1/2" - 3" Cold Section - 150 lb. Steel Flange

KILO-WATTS	IMMERSION LENGTH B		VOLTAGES 208, 240 480, 600	WATT DENSITY W/in. ²	WITHOUT THERMOSTAT CAT. No.	WITH THERMOSTAT CAT. No.	NET WT. LBS (approx.)
	mm	in.					
COPPER SHEATH - 65 WPSI (Approx.) - HIGH DENSITY							
5	406	16	1 or 3 Phase	61.7	FLC305X2016	FLC305X2016T	16
10	635	25	"	64.9	FLC310X2025	FLC310X2025T	18
15	889	35	"	63.8	FLC315X2035	FLC315X2035T	18
20	1118	44	"	64.9	FLC320X2044	FLC320X2044T	20
INCOLOY SHEATH - 65 WPSI (Approx.) - HIGH DENSITY							
5	406	16	1 or 3 Phase	61.7	FLI305X2016	FLI305X2016T	16
10	635	25	"	64.9	FLI310X2025	FLI310X2025T	18
15	864	34	"	66.1	FLI315X2034	FLI315X2034T	18
20	1118	44	"	64.9	FLI320X2044	FLI320X2044T	20
STEEL SHEATH - 23 WPSI (Approx.) - MEDIUM DENSITY							
5	813	32	1 or 3 Phase	23.7	FLO305X2032	FLO305X2032T	16
10	1499	59	"	23.3	FLO310X2059	FLO310X2059T	18
12	1829	72	"	22.4	FLO312X2072	FLO312X2072T	20
STEEL SHEATH - 10 WPSI (Approx.) - LOW DENSITY							
2	813	32	1 or 3 Phase	9.5	FLO302X2032	FLO302X2032T	18
3	1219	48	"	8.8	FLO303X2048	FLO303X2048T	18
4	1448	57	"	9.7	FLO304X2057	FLO304X2057T	20

WHEN ORDERING, PLEASE SPECIFY: Quantity, catalogue number, voltage, phase, wattage, material to be heated, flowing or static mediums, types of controls to be applied, type of metal or alloy of the container, any extra features.

CUSTOMERS MUST ALWAYS ADVISE IF FLANGE IMMERSION HEATERS ARE FOR STEAM PRESSURED APPLICATIONS

3" FLANGE HEATERS

Refer to **PAGE 2.1** for the **GENERAL RECOMMENDATIONS**

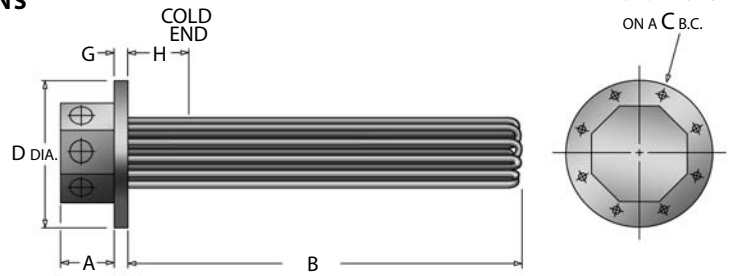

Terminal Boxes Available

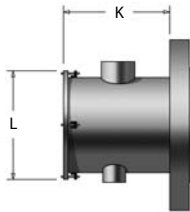

Moisture resistant Terminal Box

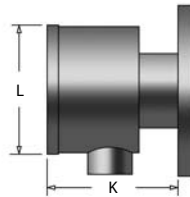

Explosion resistant Terminal Box

HEATER DIMENSION IN INCHES								
FLANGE SIZE	FLANGE RATING	A	C	D	E	F	G	H
3"	150 lb.	3 1/2	6	7 1/2	4	3/4	15/16	5 1/2
	300 lb.	3 1/2	6 5/8	8 1/4	8	7/8	1 1/8	5 1/2

TABLE 2
3" - 3" Cold Section - 150 lb. Steel Flange

KILO-WATTS	IMMERSION LENGTH B		VOLTAGES	WATT DENSITY	WITHOUT THERMOSTAT	WITH THERMOSTAT	NET WT. LBS
	mm	in.	208, 240 480, 600	W/in. ²	CAT. No.	CAT. No.	(approx.)
COPPER SHEATH - 65 WPSI (Approx.) - HIGH DENSITY							
5	406	16	1 or 3 Phase	61.7	FLC305X2416	FLC305X2416T	16
7	508	20	"	61.7	FLC307X2420	FLC307X2420T	16
10	635	25	"	64.9	FLC310X2425	FLC310X2425T	18
15	889	35	"	63.8	FLC315X2435	FLC315X2435T	18
20	1118	44	"	64.9	FLC320X2444	FLC320X2444T	20
30	889	35	"	63.8	FLC630X2435	FLC630X2435T	24
40	1118	44	"	64.9	FLC640X2444	FLC640X2444T	28
INCOLOY SHEATH - 65 WPSI (Approx.) - HIGH DENSITY							
5	406	16	1 or 3 Phase	61.7	FLI305X2416	FLI305X2416T	16
7	483	19	"	66.4	FLI307X2419	FLI307X2419T	16
10	635	25	"	64.9	FLI310X2425	FLI310X2425T	18
15	864	34	"	66.1	FLI315X2434	FLI315X2434T	18
20	1118	44	"	64.9	FLI320X2444	FLI320X2444T	20
30	889	35	"	63.8	FLI630X2435	FLI630X2435T	25
40	1118	44	"	64.9	FLI640X2444	FLI640X2444T	30
STEEL SHEATH - 23 WPSI (Approx.) - MEDIUM DENSITY							
5	813	32	1 or 3 Phase	23.7	FLO305X2432	FLO305X2432T	16
7	1118	44	"	22.7	FLO307X2444	FLO307X2444T	16
10	1499	59	"	23.3	FLO310X2459	FLO310X2459T	18
12	1829	72	"	22.4	FLO312X2472	FLO312X2472T	20
STEEL SHEATH - 10 WPSI (Approx.) - LOW DENSITY							
2	813	32	1 or 3 Phase	9.5	FLO302X2432	FLO302X2432T	18
3	1219	48	"	8.8	FLO303X2448	FLO303X2448T	18
4	1448	57	"	9.7	FLO304X2457	FLO304X2457T	20

WHEN ORDERING, PLEASE SPECIFY: Quantity, catalogue number, voltage, phase, wattage, material to be heated, flowing or static mediums, types of controls to be applied, type of metal or alloy of the container, any extra features.

CUSTOMERS MUST ALWAYS ADVISE IF FLANGE IMMERSION HEATERS ARE FOR STEAM PRESSURED APPLICATIONS

FLANGE HEATERS

immersion heaters

4" FLANGE HEATERS

Refer to **PAGE 2.1** for the **GENERAL RECOMMENDATIONS**

Terminal Boxes Available

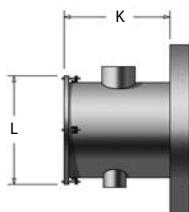

Moisture resistant Terminal Box

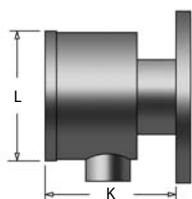

Explosion resistant Terminal Box

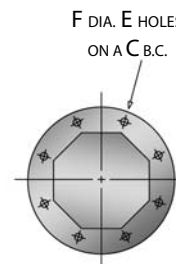
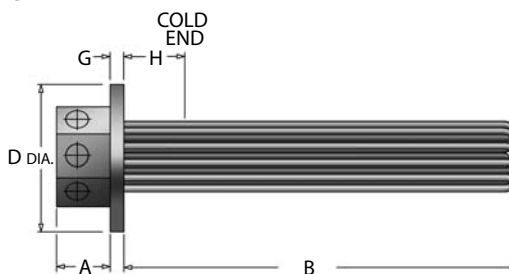

HEATER DIMENSION IN INCHES								
FLANGE SIZE	FLANGE RATING	A	C	D	E	F	G	H
4"	150 lb.	5	7 1/2	9	8	3/4	15/16	5 1/2
	300 lb.	5	7 7/8	10	8	7/8	1 1/4	5 1/2

TABLE 3
4" - 3" Cold Section - 150 lb. Steel Flange

KILO-WATTS	IMMERSION LENGTH B		VOLTAGES 208, 240 480, 600	WATT DENSITY W/in. ²	WITHOUT THERMOSTAT CAT. No.	WITH THERMOSTAT CAT. No.	NET WT. LBS (approx.)
	mm	in.					
COPPER SHEATH - 65 WPSI (Approx.) - HIGH DENSITY							
5	279	11	1 or 3 Phase	61.7	FLC605X2811	FLC605X2811T	16
7	330	13	"	61.7	FLC607X2813	FLC607X2813T	16
10	406	16	"	61.7	FLC610X2816	FLC610X2816T	18
15	533	21	"	61.7	FLC615X2821	FLC615X2821T	18
20	635	25	"	64.9	FLC620X2825	FLC620X2825T	20
25	559	22	"	64.3	FLC925X2822	FLC925X2822T	23
30	635	25	"	64.9	FLC930X2825	FLC930X2825T	24
40	787	31	"	65.8	FLC940X2831	FLC940X2831T	28
INCOLOY SHEATH - 65 WPSI (Approx.) - HIGH DENSITY							
5	279	11	1 or 3 Phase	61.7	FLI605X2811	FLI605X2811T	16
7	330	13	"	61.7	FLI607X2813	FLI607X2813T	16
10	406	16	"	61.7	FLI610X2816	FLI610X2816T	18
15	533	21	"	61.7	FLI615X2821	FLI615X2821T	18
20	635	25	"	64.9	FLI620X2825	FLI620X2825T	20
25	559	22	"	64.3	FLI925X2822	FLI925X2822T	23
30	635	25	"	64.9	FLI930X2825	FLI930X2825T	25
40	787	31	"	65.8	FLI940X2831	FLI940X2831T	30
STEEL SHEATH - 23 WPSI (Approx.) - MEDIUM DENSITY							
5	381	15	1 or 3 Phase	22.8	FLO905X2815	FLO905X2815T	16
7	483	19	"	22.1	FLO907X2819	FLO907X2819T	16
10	610	24	"	22.8	FLO910X2824	FLO910X2824T	18
12	686	27	"	23.5	FLO912X2827	FLO912X2827T	20
STEEL SHEATH - 10 WPSI (Approx.) - LOW DENSITY							
2	381	15	1 or 3 Phase	9.1	FLO902X2815	FLO902X2815T	18
3	457	18	"	10.3	FLO903X2818	FLO903X2818T	18
4	559	22	"	10.3	FLO904X2822	FLO904X2822T	20

WHEN ORDERING, PLEASE SPECIFY: Quantity, catalogue number, voltage, phase, wattage, material to be heated, flowing or static mediums, types of controls to be applied, type of metal or alloy of the container, any extra features.

CUSTOMERS MUST ALWAYS ADVISE IF FLANGE IMMERSION HEATERS ARE FOR STEAM PRESSURED APPLICATIONS

5" FLANGE HEATERS

Refer to **PAGE 2.1** for the **GENERAL RECOMMENDATIONS**

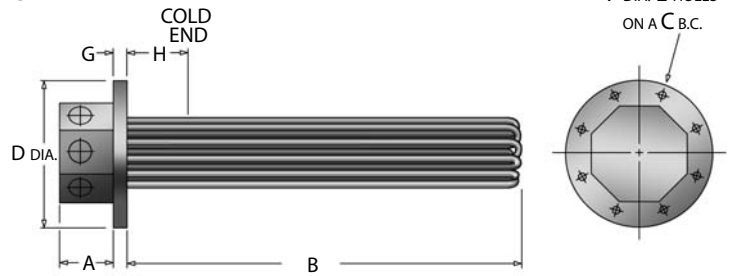

Terminal Boxes Available

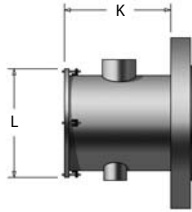

Moisture resistant Terminal Box

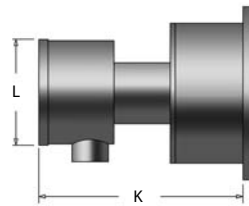

Explosion resistant Terminal Box

HEATER DIMENSION IN INCHES								
FLANGE SIZE	FLANGE RATING	A	C	D	E	F	G	H
5"	150 lb.	5	8 1/2	10	8	7/8	15/16	6 3/4
	300 lb.	5	9 1/4	11	8	7/8	1 3/8	6

TABLE 4
5" - 3" Cold Section - 150 lb. Steel Flange

KILO-WATTS	IMMERSION LENGTH B		VOLTAGES 208, 240 480, 600	WATT DENSITY W/in. ²	WITHOUT THERMOSTAT CAT. No.	WITH THERMOSTAT CAT. No.	NET WT. LBS (approx.)
	mm	in.					
COPPER SHEATH - 65 WPSI (Approx.) - HIGH DENSITY							
10	406	16	1 or 3 Phase	66.7	FLC610X3016	FLC610X3016T	25
15	533	21	"	64.9	FLC615X3021	FLC615X3021T	27
20	635	25	"	67.6	FLC620X3025	FLC620X3025T	27
25	559	22	"	67.4	FLC925X3022	FLC925X3022T	32
30	635	25	"	67.6	FLC930X3025	FLC930X3025T	35
40	787	31	"	67.8	FLC940X3031	FLC940X3031T	37
50	965	38	"	65.8	FLC950X3038	FLC950X3038T	39
55	1041	41	"	66.0	FLC955X3041	FLC955X3041T	42
INCOLOY SHEATH - 65 WPSI (Approx.) - HIGH DENSITY							
10	406	16	1 or 3 Phase	66.7	FLI610X3016	FLI610X3016T	25
15	533	21	"	64.9	FLI615X3021	FLI615X3021T	27
20	635	25	"	67.6	FLI620X3025	FLI620X3025T	27
25	559	22	"	67.4	FLI925X3022	FLI925X3022T	32
30	635	25	"	67.6	FLI930X3025	FLI930X3025T	35
40	787	31	"	67.8	FLI940X3031	FLI940X3031T	37
50	965	38	"	65.8	FLI950X3038	FLI950X3038T	39
55	1041	41	"	66.0	FLI955X3041	FLI955X3041T	43
STEEL SHEATH - 23 WPSI (Approx.) - MEDIUM DENSITY							
5	381	15	1 or 3 Phase	24.9	FLO905X3015	FLO905X3015T	16
7	483	19	"	23.5	FLO907X3019	FLO907X3019T	16
10	610	24	"	23.8	FLO910X3024	FLO910X3024T	18
12	686	27	"	24.4	FLO912X3027	FLO912X3027T	20
STEEL SHEATH - 10 WPSI (Approx.) - LOW DENSITY							
2	381	15	1 or 3 Phase	10.0	FLO902X3015	FLO902X3015T	18
3	457	18	"	11.0	FLO903X3018	FLO903X3018T	18
4	559	22	"	10.8	FLO904X3022	FLO904X3022T	20

WHEN ORDERING, PLEASE SPECIFY: Quantity, catalogue number, voltage, phase, wattage, material to be heated, flowing or static mediums, types of controls to be applied, type of metal or alloy of the container, any extra features.

CUSTOMERS MUST ALWAYS ADVISE IF FLANGE IMMERSION HEATERS ARE FOR STEAM PRESSURED APPLICATIONS

FLANGE HEATERS

immersion heaters

6" FLANGE HEATERS

Refer to **PAGE 2.1** for the **GENERAL RECOMMENDATIONS**

Terminal Boxes Available

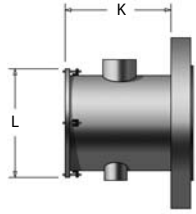

Moisture resistant Terminal Box

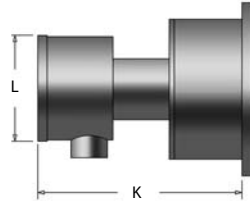

Explosion resistant Terminal Box

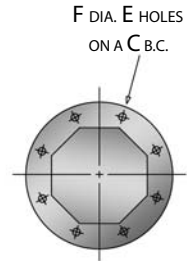
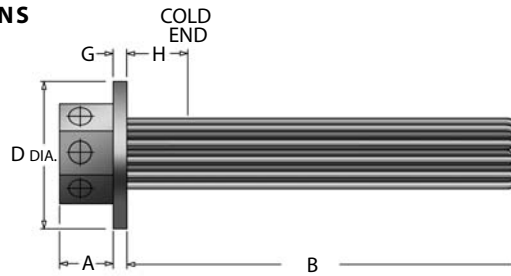

HEATER DIMENSION IN INCHES								
FLANGE SIZE	FLANGE RATING	A	C	D	E	F	G	H
6"	150 lb.	5	9 1/2	11	8	7/8	1	6 3/4
	300 lb.	5	10 5/8	12 1/2	12	7/8	1 7/16	6

TABLE 5
6" - 3" Cold Section - 150 lb. Steel Flange

KILO-WATTS	IMMERSION LENGTH B mm in.	VOLTAGES 208, 240 480, 600	WATT DENSITY W/in. ²	WITHOUT THERMOSTAT CAT. No.	WITH THERMOSTAT CAT. No.	NET WT. LBS (approx.)
COPPER SHEATH - 65 WPSI (Approx.) - HIGH DENSITY						
30	533 21	1 or 3 Phase	64.9	FLC1230X1021	FLC1230X1021T	52
40	635 25	"	67.6	FLC1240X1025	FLC1240X1025T	52
45	711 28	"	65.3	FLC1245X1028	FLC1245X1028T	52
50	762 30	"	66.3	FLC1250X1030	FLC1250X1030T	52
60	737 29	"	66.5	FLC1560X1029	FLC1560X1029T	62
70	838 33	"	65.8	FLC1570X1033	FLC1570X1033T	66
80	914 36	"	67.5	FLC1580X1036	FLC1580X1036T	70
90	1016 40	"	66.8	FLC1590X1040	FLC1590X1040T	70
INCOLOY SHEATH - 65 WPSI (Approx.) - HIGH DENSITY						
30	533 21	1 or 3 Phase	64.9	FLI1230X1021	FLI1230X1021T	52
35	584 23	"	66.4	FLI1235X1023	FLI1235X1023T	52
40	635 25	"	67.6	FLI1240X1025	FLI1240X1025T	52
45	711 28	"	65.3	FLI1245X1028	FLI1245X1028T	52
50	762 30	"	66.3	FLI1250X1030	FLI1250X1030T	52
60	737 29	"	66.5	FLI1560X1029	FLI1560X1029T	62
70	838 33	"	65.8	FLI1570X1033	FLI1570X1033T	66
80	914 36	"	67.5	FLI1580X1036	FLI1580X1036T	70
90	1016 40	"	66.8	FLI1590X1040	FLI1590X1040T	70
STEEL SHEATH - 23 WPSI (Approx.) - MEDIUM DENSITY						
15	559 22	1 or 3 Phase	24.3	FLO1515X1022	FLO1515X1022T	51
20	686 27	"	24.4	FLO1520X1027	FLO1520X1027T	55
25	813 32	"	24.4	FLO1525X1032	FLO1525X1032T	65
30	965 38	"	23.7	FLO1530X1038	FLO1530X1038T	67
35	1092 43	"	23.8	FLO1535X1043	FLO1535X1043T	68
40	1219 48	"	23.9	FLO1540X1048	FLO1540X1048T	70
45	1346 53	"	24.0	FLO1545X1053	FLO1545X1053T	74
60	1753 69	"	23.8	FLO1560X1069	FLO1560X1069T	83
STEEL SHEATH - 10 WPSI (Approx.) - LOW DENSITY						
10	787 31	1 or 3 Phase	10.2	FLO1510X1031	FLO1510X1031T	52
15	1143 45	"	9.7	FLO1515X1045	FLO1515X1045T	65
20	1448 57	"	9.8	FLO1520X1057	FLO1520X1057T	78

WHEN ORDERING, PLEASE SPECIFY: Quantity, catalogue number, voltage, phase, wattage, material to be heated, flowing or static mediums, types of controls to be applied, type of metal or alloy of the container, any extra features.

CUSTOMERS MUST ALWAYS ADVISE IF FLANGE IMMERSION HEATERS ARE FOR STEAM PRESSURED APPLICATIONS

8" FLANGE HEATERS

Refer to **PAGE 2.1** for the **GENERAL RECOMMENDATIONS**

Terminal Boxes Available

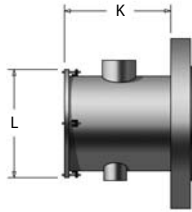

Moisture resistant Terminal Box

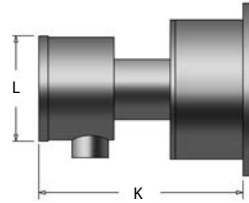

Explosion resistant Terminal Box

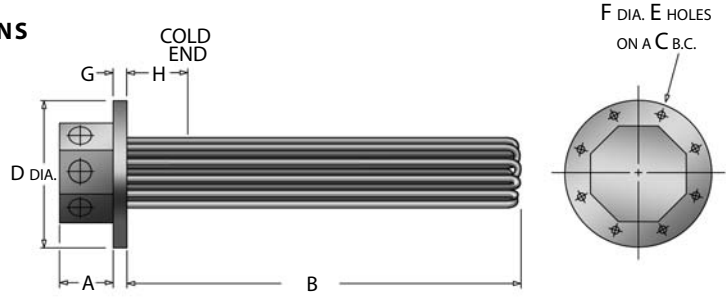

HEATER DIMENSION IN INCHES							
FLANGE SIZE	FLANGE RATING	A	C	D	E	F	H
8"	150 lb.	5	11 3/4	13 1/2	8	7/8	6 3/4
	300 lb.	5	13	15	12	1	6

TABLE 6
8" - 3" Cold Section - 150 lb. Steel Flange

KILO-WATTS	IMMERSION LENGTH B		VOLTAGES 208, 240 480, 600	WATT DENSITY W/in. ²	WITHOUT THERMOSTAT		WITH THERMOSTAT		NET WT. LBS (approx.)
	mm	in.			CAT. No.		CAT. No.		
COPPER SHEATH - 65 WPSI (Approx.) - HIGH DENSITY									
50	584	23	1 or 3 Phase	63.3	FLC1850X1223	FLC1850X1223T			79
70	737	29	"	64.7	FLC1870X1229	FLC1870X1229T			82
90	889	35	"	65.5	FLC1890X1235	FLC1890X1235T			84
110	1041	41	"	66.0	FLC18110X1241	FLC18110X1241T			86
120	1118	44	"	66.2	FLC18120X1244	FLC18120X1244T			92
140	914	36	"	65.6	FLC27140X1236	FLC27140X1236T			95
180	1118	44	"	66.2	FLC27180X1244	FLC27180X1244T			125
210	1270	50	"	66.6	FLC27210X1250	FLC27210X1250T			125
INCOLOY SHEATH - 65 WPSI (Approx.) - HIGH DENSITY									
50	584	23	1 or 3 Phase	63.3	FLI1850X1223	FLI1850X1223T			79
70	737	29	"	64.7	FLI1870X1229	FLI1870X1229T			83
90	889	35	"	65.5	FLI1890X1235	FLI1890X1235T			88
110	1041	41	"	66.0	FLI18110X1241	FLI18110X1241T			92
120	1118	44	"	66.2	FLI18120X1244	FLI18120X1244T			95
140	914	36	"	65.6	FLI27140X1236	FLI27140X1236T			110
160	1016	40	"	66.0	FLI27160X1240	FLI27160X1240T			114
180	1118	44	"	66.2	FLI27180X1244	FLI27180X1244T			118
210	1270	50	"	66.6	FLI27210X1250	FLI27210X1250T			126
250	1473	58	"	66.9	FLI27250X1258	FLI27250X1258T			130
STEEL SHEATH - 23 WPSI (Approx.) - MEDIUM DENSITY									
40	762	30	1 or 3 Phase	23.6	FLO2740X1230	FLO2740X1230T			100
45	813	32	"	24.4	FLO2745X1232	FLO2745X1232T			100
50	889	35	"	24.3	FLO2750X1235	FLO2750X1235T			120
55	965	38	"	24.1	FLO2755X1238	FLO2755X1238T			140
60	1041	41	"	24.0	FLO2760X1241	FLO2760X1241T			140
STEEL SHEATH - 10 WPSI (Approx.) - LOW DENSITY									
20	813	32	1 or 3 Phase	10.9	FLO2720X1232	FLO2720X1232T			125
40	1448	57	"	10.9	FLO2740X1257	FLO2740X1257T			125
60	2083	82	"	10.9	FLO2760X1282	FLO2760X1282T			125

WHEN ORDERING, PLEASE SPECIFY: Quantity, catalogue number, voltage, phase, wattage, material to be heated, flowing or static mediums, types of controls to be applied, type of metal or alloy of the container, any extra features.

CUSTOMERS MUST ALWAYS ADVISE IF FLANGE IMMERSION HEATERS ARE FOR STEAM PRESSURED APPLICATIONS

FLANGE HEATERS

immersion heaters

10" FLANGE HEATERS

Refer to **PAGE 2.1** for the **GENERAL RECOMMENDATIONS**

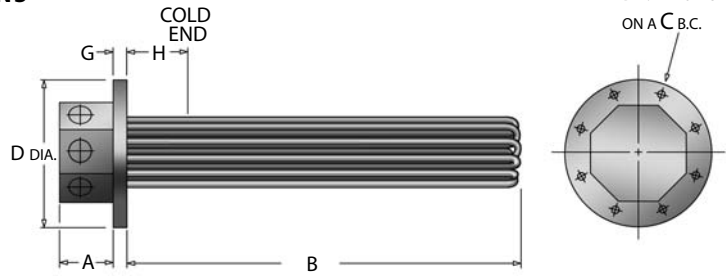
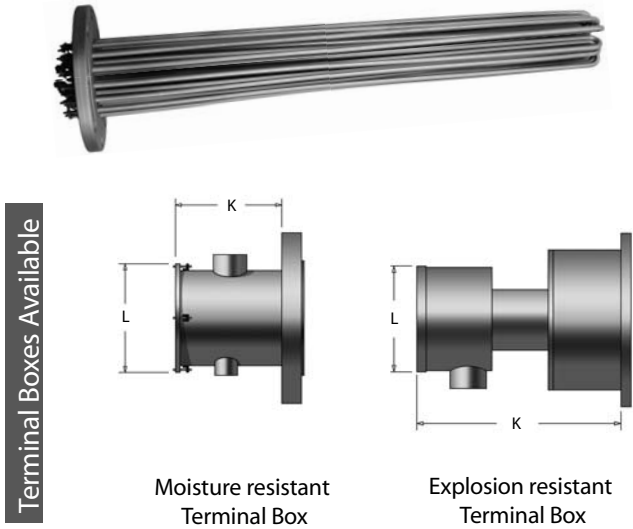

HEATER DIMENSION IN INCHES								
FLANGE SIZE	FLANGE RATING	A	C	D	E	F	G	H
10"	150 lb.	8	14 1/4	16	12	1	1 3/16	10
	300 lb.	8	15 1/4	17 1/2	16	1 1/8	1 7/8	9 1/4

TABLE 7
10" - 3" Cold Section - 150 lb. Steel Flange

KILO-WATTS	IMMERSION LENGTH B mm in.	VOLTAGES 208, 240 480, 600	WATT DENSITY W/in ²	WITHOUT THERMOSTAT CAT. No.	WITH THERMOSTAT CAT. No.	NET WT. LBS (approx.)
COPPER SHEATH - 65 WPSI (Approx.) - HIGH DENSITY						
100	660 26	1 or 3 Phase	64.3	FLC36100X1426	-----	79
140	813 32	"	65.4	FLC36140X1432	-----	82
160	889 35	"	65.8	FLC36160X1435	-----	84
200	1067 42	"	64.3	FLC36200X1442	-----	92
240	991 39	"	63.8	FLC48240X1435	-----	95
280	1092 43	"	65.4	FLC48280X1443	-----	110
300	1168 46	"	64.3	FLC48300X1446	-----	125
320	1219 48	"	64.9	FLC48320X1448	-----	125
INCOLOY SHEATH - 65 WPSI (Approx.) - HIGH DENSITY						
100	660 26	1 or 3 Phase	64.3	FLI36100X1426	-----	79
140	813 32	"	65.4	FLI36140X1432	-----	83
160	889 35	"	65.8	FLI36160X1435	-----	88
200	1067 42	"	64.3	FLI36200X1442	-----	95
240	991 39	"	63.8	FLI48240X1439	-----	110
300	1168 46	"	64.3	FLI48300X1446	-----	118
320	1219 48	"	64.9	FLI48320X1448	-----	126
STEEL SHEATH - 23 WPSI (Approx.) - MEDIUM DENSITY						
100	1118 44	1 or 3 Phase	22.7	FLO48100X1444	-----	84
120	1245 49	"	23.7	FLO48120X1449	-----	88
140	1473 58	"	22.5	FLO48140X1458	-----	92
160	1575 62	"	23.7	FLO48160X1462	-----	92
180	1753 69	"	23.5	FLO48180X1469	-----	92
STEEL SHEATH - 10 WPSI (Approx.) - LOW DENSITY						
70	1600 63	1 or 3 Phase	10.2	FLO4870X1463	-----	90
80	1702 67	"	10.8	FLO4880X1467	-----	100
100	2083 82	"	10.7	FLO48100X1482	-----	100

WHEN ORDERING, PLEASE SPECIFY: Quantity, catalogue number, voltage, phase, wattage, material to be heated, flowing or static mediums, types of controls to be applied, type of metal or alloy of the container, any extra features.

CUSTOMERS MUST ALWAYS ADVISE IF FLANGE IMMERSION HEATERS ARE FOR STEAM PRESSURED APPLICATIONS

12" FLANGE HEATERS

Refer to **PAGE 2.1** for the **GENERAL RECOMMENDATIONS**

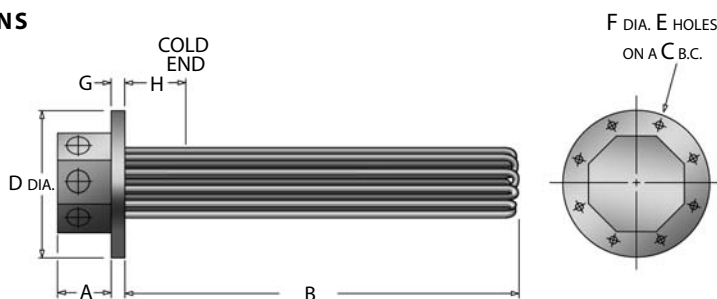

Terminal Boxes Available

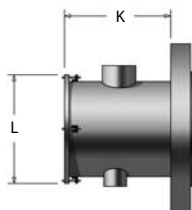

Moisture resistant Terminal Box

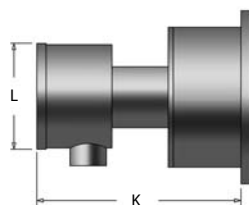

Explosion resistant Terminal Box

HEATER DIMENSION IN INCHES							
FLANGE SIZE	FLANGE RATING	A	C	D	E	F	H
12"	150 lb.	8	17	19	12	1	1 1/4
	300 lb.	8	17 3/4	20 1/2	16	1 1/4	2

TABLE 8
12" - 3" Cold Section - 150 lb. Steel Flange

KILO-WATTS	IMMERSION LENGTH B		VOLTAGES	WATT DENSITY	WITHOUT THERMOSTAT	WITH THERMOSTAT	NET WT. LBS (approx.)
	mm	in.	208, 240 480, 600	W/in. ²	CAT. No.	CAT. No.	
COPPER SHEATH - 65 WPSI (Approx.) - HIGH DENSITY							
150	711	28	1 or 3 Phase	63.4	FLC48150X1628	-----	100
175	787	31	"	63.5	FLC48175X1631	-----	100
200	838	33	"	66.3	FLC48200X1633	-----	100
250	1016	40	"	63.7	FLC48250X1640	-----	100
300	1168	46	"	63.8	FLC48300X1646	-----	120
400	1219	48	"	64.5	FLC60400X1648	-----	120
450	1346	53	"	64.2	FLC60450X1653	-----	120
500	1448	57	"	65.3	FLC60500X1657	-----	125
INCOLOY SHEATH - 65 WPSI (Approx.) - HIGH DENSITY							
150	711	28	1 or 3 Phase	63.4	FLI48150X1628	-----	100
175	787	31	"	63.5	FLI48175X1631	-----	100
200	838	33	"	66.3	FLI48200X1633	-----	100
250	1016	40	"	63.7	FLI48250X1640	-----	100
300	1168	46	"	63.8	FLI48300X1646	-----	120
400	1219	48	"	64.5	FLI60400X1648	-----	120
500	1448	57	"	65.3	FLI60500X1657	-----	125
STEEL SHEATH - 23 WPSI (Approx.) - MEDIUM DENSITY							
150	1245	49	1 or 3 Phase	23.6	FLO60150X1649	-----	125
200	1575	62	"	23.6	FLO60200X1662	-----	125
250	1905	75	"	23.6	FLO60250X1675	-----	125
300	2184	86	"	24.3	FLO60300X1686	-----	125
STEEL SHEATH - 10 WPSI (Approx.) - LOW DENSITY							
100	1727	68	1 or 3 Phase	10.6	FLO60100X1668	-----	125
150	2337	92	"	11.3	FLO60150X1692	-----	125

WHEN ORDERING, PLEASE SPECIFY: Quantity, catalogue number, voltage, phase, wattage, material to be heated, flowing or static mediums, types of controls to be applied, type of metal or alloy of the container, any extra features.

CUSTOMERS MUST ALWAYS ADVISE IF FLANGE IMMERSION HEATERS ARE FOR STEAM PRESSURED APPLICATIONS

FLANGE HEATERS

immersion heaters

14" FLANGE HEATERS

Refer to **PAGE 2.1** for the **GENERAL RECOMMENDATIONS**

HEATER DIMENSION IN INCHES							
FLANGE SIZE	FLANGE RATING	A	C	D	E	F	H
14"	150 lb.	8	18 3/4	21	12	1 1/8	9 3/4
	300 lb.	8	20 1/4	23	20	1 1/4	9

TABLE 9
14" - 3" Cold Section - 150 lb. Steel Flange

KILO-WATTS	IMMERSION LENGTH B		VOLTAGES 208, 240 480, 600	WATT DENSITY W/in. ²	WITHOUT THERMOSTAT	WITH THERMOSTAT	NET WT. LBS (approx.)
	mm	in.			CAT. No.	CAT. No.	
COPPER SHEATH - 65 WPSI (Approx.) - HIGH DENSITY							
250	864	34	1 or 3 Phase	63.6	FLC60250X1834	-----	130
300	965	38	"	65.5	FLC60300X1838	-----	150
350	1092	43	"	64.9	FLC60350X1843	-----	150
400	1219	48	"	64.5	FLC60400X1848	-----	150
500	1118	44	"	64.3	FLC84500X1844	-----	170
600	1295	51	"	64.1	FLC84600X1851	-----	170
650	1397	55	"	63.3	FLC84650X1855	-----	170
700	1473	58	"	63.9	FLC84700X1858	-----	170
INCOLOY SHEATH - 65 WPSI (Approx.) - HIGH DENSITY							
250	864	34	1 or 3 Phase	63.6	FLI60250X1834	-----	130
300	965	38	"	65.5	FLI60300X1838	-----	150
350	1092	43	"	64.9	FLI60350X1843	-----	150
400	1219	48	"	64.5	FLI60400X1848	-----	150
500	1118	44	"	64.3	FLI84500X1844	-----	170
600	1295	51	"	64.1	FLI84600X1851	-----	170
700	1473	58	"	63.9	FLI84700X1858	-----	170
STEEL SHEATH - 23 WPSI (Approx.) - MEDIUM DENSITY							
150	889	35	1 or 3 Phase	26.2	FLO84150X1835	-----	170
200	1143	45	"	25.0	FLO84200X1845	-----	170
250	1321	52	"	26.1	FLO84250X1852	-----	170
300	1575	62	"	25.3	FLO84300X1862	-----	170
STEEL SHEATH - 10 WPSI (Approx.) - LOW DENSITY							
100	1219	48	1 or 3 Phase	11.5	FLO84100X1848	-----	140
150	1727	68	"	11.3	FLO84150X1868	-----	180

WHEN ORDERING, PLEASE SPECIFY: Quantity, catalogue number, voltage, phase, wattage, material to be heated, flowing or static mediums, types of controls to be applied, type of metal or alloy of the container, any extra features.

CUSTOMERS MUST ALWAYS ADVISE IF FLANGE IMMERSION HEATERS ARE FOR STEAM PRESSURED APPLICATIONS

EXTRA FEATURES	DESCRIPTION
VOLTAGE	WATTCO™ flange heaters are custom-built and supplied with voltages up to 600V.
WATTAGE	Custom made heaters can be supplied with any requested wattage.
LENGTH	WATTCO™ flange heaters are supplied with immersed lengths of a maximum of 180'. When the immersed length exceeds 50', it is recommended to install an internal vessel support.
EXTRA HEAVY WALL SHEATH	Heavy wall sheath (0.049" or 0.065" thickness) is provided in: • Incoloy® • Inconel® • Steel • Stainless steel
FLANGE SIZES AND RATINGS	Refer to the Welding flanges section on page 2.12 and 2.13
PASSIVATION	Available Incoloy® and stainless steel sheathed heaters are supplied with chemically passivated sheaths. Note: Chemically passivated sheaths are highly corrosion resistant in most applications. Passivation process is carried out through electropolishing. WATTCO™ stainless steel flange heaters can come with passivated wetted surfaces (Teflon on top of the sheath).
WELDED ELEMENTS	WATTCO™ standard flange heaters are made of elements that are silver-brazed, 'Tig' or welded to the flange. Heaters are supplied with welded elements for the following sheath material: • Incoloy® • Stainless steel • Steel • Copper
BUILT-IN THERMOSTAT WELL	Built-in thermostat wells can be installed upon request. When ordering, please provide length and internal diameter.
BUILT-IN HIGH LIMITS AND THERMOSTATS	For process temperature control, built-in high limits and thermostats can be installed upon request. Standard built-in thermostats: One-pole device of a maximum of 240V up to 30 amps.
BUILT-IN THERMOCOUPLES	Thermocouples can be mounted to provide sheath limit protection or temperature control. Configured temperature control and power controls are available to meet the requirements of any application.
VENTED OR STILTED HOUSINGS	Vented or stilted housings prevent the connection wire from overheating in many high temperature applications.
SPECIAL TERMINAL HOUSINGS	Special terminal housings for all types of flange heaters can be made: • Moisture resistant • Explosion resistant When requesting an explosion-proof housing, please provide: • Class • Division or zone • Group • Temperature code for unsafe locations (Refer to Figures 1-4)

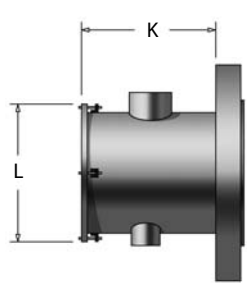

FIG. 1

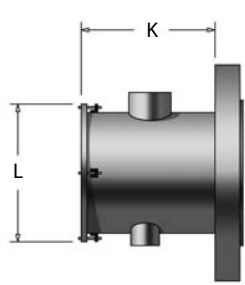

FIG. 2

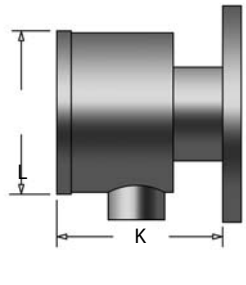

FIG. 3

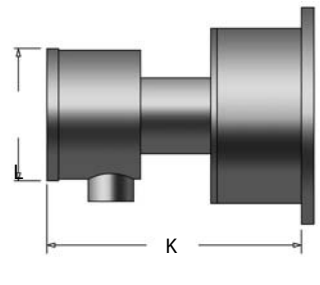

FIG. 4

	FLG. SIZE	FIG. NO.	NO THERMOSTAT		WITH THERMOSTAT	
			K	L	K	L
MOISTURE RESISTANT	2 1/2"	1	4 3/4"	4 1/4"	8 1/2"	4 1/4"
	3"	1	4 3/4"	4 1/4"	8 1/2"	4 1/4"
	4"	1	5 1/8"	6"	8 1/2"	6"
	5"	2	7"	9 1/4"	—	—
	6"	2	7"	10 1/8"	—	—
	8"	2	9"	12 1/8"	—	—
	10"	2	9"	14 3/4"	—	—
	12"	2	9"	16 3/4"	—	—
	14"	2	9"	18 3/4"	—	—

	FLG. SIZE	FIG. NO.	NO THERMOSTAT		WITH THERMOSTAT	
			K	L	K	L
EXPLOSION RESISTANT	2 1/2"	3	5 3/4"	4"	9 1/4"	4"
	3"	3	5 3/4"	4"	9 1/4"	4"
	4"	3	6 1/8"	5 5/8"	9 1/4"	5 5/8"
	5"	4	7 1/2"	7 1/2"	—	—
	6"	4	7 1/2"	9"	—	—
	8"	4	8 1/8"	11"	—	—
	10"	4	10 1/8"	13 1/2"	—	—
	12"	4	10 1/8"	15 1/2"	—	—
	14"	4	10 1/8"	17 1/2"	—	—

For S.I. conversion to metric multiply by 25.4

WELDING FLANGES / FORGED STEEL ASTM A 105

CLASS 150 FLANGES

CONSTRUCTION	
CLASS 150 FLANGES	DIMENSIONS
Carbon steel to ASTM A 105.	All dimensions are in inches and comply with ANSI B16.5 when applicable.
SA 105 flanges can be supplied upon request.	NPS 22: interpolated.
Material of NPS 26 and up complies with ASTM A181 grades 1 and 2.	NPS 26 to NPS 42: same flange drilling dimensions as class 125 cast iron flanges.
Flanges are: furnished, faced, drilled, spot faced or back faced.	Bolt holes: 1/8 inch larger than bolt diameter.
Thread lengths: - ANSI for Pipe Threads - ANSI B2.1 (additional depth or height of facing is required to thread length)	Flanges are indicated with shown dimensions.
	Dimensions shown match ANSI B36.10 inside diameter of a standard wall pipe.
	Thickness of two nuts is included in length of alloy steel stud bolts.
	Thickness of lap not included in length shown.
	For lapped to lapped dimension, additional thickness of both laps are required.
	For lapped to 1/16 inch raised face, additional thickness of one lap is required.
	For lapped to any other facing, combining facing and one lap will result in the separation of the flanges.

Note: Contact us at 1.800.492.8826 for pressure-temperature ratings

WELDING NECK - FIG. 1

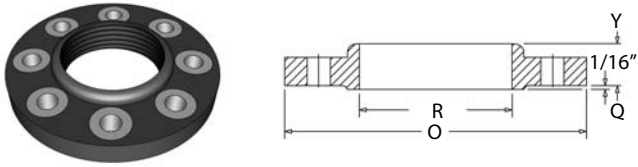

THREADED - FIG. 2

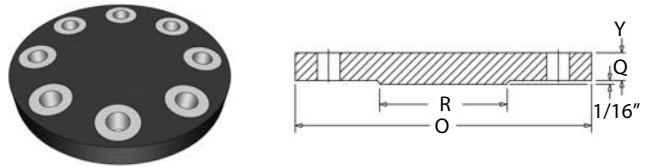

TABLE 1
Class 150 Flanges

NOMINAL PIPE SIZE	OUTSIDE DIAM. OF FLANGE O	THICKNESS OF FLANGE Q (min.)	DIAM. OF RAISED FACE R	DIAM. OF HUB AT BASE X	NO. OF BOLT HOLES	DIAM. OF BOLTS	DIAM. OF BOLT CIRCLE	LENGTH OF BOLTS			LENGTH THRU HUB		
								STUD		MACHINE	WELDING NECK Y	SLIP-ON, THRD SOCKET Y	LAP JOINT Y
								1/16" RAISED FACE	RING JOINT				
1/2	3 1/2	7/16	1 3/8	1 3/16	4	1/2	2 3/8	2 1/4	—	1 3/4	1 7/8	5/8	5/8
3/4	3 7/8	1/2	1 11/16	1 1/2	4	1/2	2 3/4	2 1/4	—	2	2 1/16	5/8	5/8
1	4 1/4	9/16	2	1 15/16	4	1/2	3 1/8	2 1/2	3	2	2 3/16	11/16	11/16
1 1/4	4 5/8	5/8	2 1/2	2 5/16	4	1/2	3 1/2	2 1/2	3	2 1/4	2 1/4	13/16	13/16
1 1/2	5	11/16	2 7/8	2 9/16	4	1/2	3 7/8	2 3/4	3 1/4	2 1/4	2 7/16	7/8	7/8
2	6	3/4	3 5/8	3 7/16	4	5/8	4 3/4	3	3 1/2	2 3/4	2 1/2	1	1
2 1/2	7	7/8	4 1/8	3 9/16	4	5/8	5 1/2	3 1/4	3 3/4	3	2 3/4	1 1/8	1 1/8
3	7 1/2	15/16	5	4 1/4	4	5/8	6	3 1/2	4	3	2 3/4	1 3/16	1 3/16
3 1/2	8 1/2	15/16	5 1/2	4 13/16	8	5/8	7	3 1/2	4	3	2 13/16	1 1/4	1 1/4
4	9	15/16	6 3/16	5 5/16	8	5/8	7 1/2	3 1/2	4	3	3	1 5/16	1 5/16
5	10	15/16	7 5/16	6 7/16	8	3/4	8 1/2	3 3/4	4 1/4	3 1/4	3 1/2	1 7/16	1 7/16
6	11	1	8 1/2	7 9/16	8	3/4	9 1/2	3 3/4	4 1/4	3 1/4	3 1/2	1 9/16	1 9/16
8	13 1/2	1 1/8	10 5/8	9 11/16	8	3/4	11 3/4	4	4 1/2	3 1/2	4	1 3/4	1 3/4
10	16	1 3/16	12 3/4	12	12	7/8	14 1/4	4 1/2	5	3 3/4	4	1 15/16	1 15/16
12	19	1 1/4	15	14 3/8	12	7/8	17	4 1/2	5	4	4 1/2	2 3/16	2 3/16
14	21	1 3/8	16 1/4	15 3/4	12	1	18 3/4	5	5 1/2	4 1/4	5	2 1/4	3 1/8
16	23 1/2	1 7/16	18 1/2	18	16	1	21 1/4	5 1/4	5 3/4	4 1/2	5	2 1/2	3 7/16
18	25	1 9/16	21	19 7/8	16	1 1/8	22 3/4	5 3/4	6 1/4	4 3/4	5 1/2	2 11/16	3 13/16
20	27 1/2	1 11/16	23	22	20	1 1/8	25	6	6 1/2	5 1/4	5 11/16	2 7/8	4 1/16
22	29 1/2	1 13/16	25 1/4	24	20	1 1/4	27 1/4	6 1/2	7	5 1/2	5 7/8	3 1/8	4 1/4
24	32	1 7/8	27 1/4	26 1/8	20	1 1/4	29 1/2	6 3/4	7 1/4	5 3/4	6	3 1/4	4 3/8
26	34 1/4	2	29 1/4	28 1/2	24	1 1/4	31 3/4	7	—	6	5	3 3/8	—
28	36 1/2	2 1/16	31 1/4	30 3/4	28	1 1/4	34	7	—	6	5 1/16	3 7/16	—
30	38 3/4	2 1/8	33 3/4	32 3/4	28	1 1/4	36	7 1/4	—	6 1/4	5 1/8	3 1/2	—
32	41 3/4	2 1/4	35 3/4	35	28	1 1/2	38 1/2	8	—	6 3/4	5 1/4	3 5/8	—
34	43 3/4	2 5/16	37 3/4	37	32	1 1/2	40 1/2	8	—	7	5 5/16	3 11/16	—
36	46	2 3/8	40 1/4	39 1/4	32	1 1/2	42 3/4	8 1/4	—	7	5 3/8	3 3/4	—
42	53	2 5/8	47	46	36	1 1/2	49 1/2	8 3/4	—	7 1/2	5 3/8	4	—

WELDING FLANGES / FORGED STEEL ASTM A 105

CLASS 300 FLANGES

CONSTRUCTION	
CLASS 300 FLANGES	DIMENSIONS
Carbon steel to ASTM A 105.	All dimensions are in inches and comply with ANSI B16.5 when applicable.
SA 105 flanges can be supplied upon request.	NPS 22: interpolated.
Material of NPS 26 and up complies with ASTM A181 grades 1 and 2.	NPS 26 to NPS 42: same flange drilling dimensions as class 125 cast iron flanges.
Flanges are: furnished, faced, drilled, spot faced or back faced.	Bolt holes: 1/8 inch larger than bolt diameter.
	Flanges are indicated with shown dimensions.
	Dimensions shown match ANSI B36.10 inside diameter of a standard wall pipe.
	Thickness of two nuts is included in length of alloy steel stud bolts.
	Thickness of lap not included in length shown.
	For lapped to lapped dimension, additional thickness of both laps are required.
	For lapped to 1/16 inch raised face, additional thickness of one lap is required.
	For lapped to any other facing, combining facing and one lap will result in the separation of the flanges.
Thread lengths: - ANSI for Pipe Threads. - ANSI B2.1 (additional depth or height of facing is required to thread length).	

Note: Contact us at 1.800.492.8826 for pressure-temperature ratings

WELDING NECK - FIG. 3

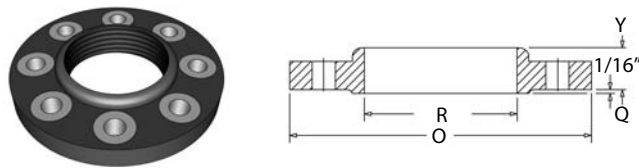

THREADED - FIG. 4

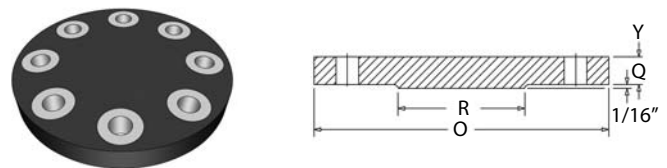

**TABLE 2
Class 300 Flange**

NOMINAL PIPE SIZE	OUTSIDE DIAM. OF FLANGE O	THICKNESS OF FLANGE Q (min.)	DIAM. OF RAISED FACE R	DIAM. OF HUB AT BASE X	NO. OF BOLT HOLES	DIAM. OF BOLTS	DIAM. OF BOLT CIRCLE	LENGTH OF BOLTS			LENGTH THRU HUB		
								STUD		MACHINE	WELDING NECK Y	SLIP-ON, TH'RD SOCKET Y	LAP JOINT Y
								1/16" RAISED FACE	RING JOINT	1/16" RAISED FACE			
1/2	3 3/4	9/16	1 3/8	1 1/2	4	1/2	2 5/8	2 1/2	3	2	2 1/16	7/8	7/8
3/4	4 5/8	5/8	1 11/16	1 7/8	4	5/8	3 1/4	2 3/4	3 1/4	2 1/2	2 1/4	1	1
1	4 7/8	11/16	2	2 1/8	4	5/8	3 1/2	3	3 1/2	2 1/2	2 7/16	1 1/16	1 1/16
1 1/4	5 1/4	3/4	2 1/2	2 1/2	4	5/8	3 7/8	3	3 1/2	2 3/4	2 9/16	1 1/16	1 1/16
1 1/2	6 1/8	13/16	2 7/8	2 3/4	4	3/4	4 1/2	3 1/2	4	3	2 11/16	1 3/16	1 3/16
2	6 1/2	7/8	3 5/8	3 5/16	8	5/8	5	3 1/4	4	3	2 3/4	1 5/16	1 5/16
2 1/2	7 1/2	1	4 1/8	3 15/16	8	3/4	5 7/8	3 3/4	4 1/2	3 1/4	3	1 1/2	1 1/2
3	8 1/4	1 1/8	5	4 5/8	8	3/4	6 5/8	4	4 3/4	3 1/2	3 1/8	1 11/16	1 11/16
3 1/2	9	1 3/16	5 1/2	5 1/4	8	3/4	7 1/4	4 1/4	5	3 3/4	3 3/16	1 3/4	1 3/4
4	10	1 1/4	6 3/16	5 3/4	8	3/4	7 7/8	4 1/4	5	3 3/4	3 3/8	1 7/8	1 7/8
5	11	1 3/8	7 5/16	7	8	3/4	9 1/4	4 1/2	5 1/4	4	3 7/8	2	2
6	12 1/2	1 7/16	8 1/2	8 1/8	12	3/4	10 5/8	4 3/4	5 1/2	4 1/4	3 7/8	2 1/16	2 1/16
8	15	1 5/8	10 5/8	10 1/4	12	7/8	13	5 1/4	6	4 3/4	4 3/8	2 7/16	2 7/16
10	17 1/2	1 7/8	12 3/4	12 5/8	16	1	15 1/4	6	6 3/4	5 1/4	4 5/8	2 5/8	3 3/4
12	20 1/2	2	15	14 3/4	16	1 1/8	17 3/4	6 1/2	7 1/4	5 3/4	5 1/8	2 7/8	4
14	23	2 1/8	16 1/4	16 3/4	20	1 1/8	20 1/4	6 3/4	7 1/2	6	5 5/8	3	4 3/8
16	25 1/2	2 1/4	18 1/2	19	20	1 1/4	22 1/2	7 1/4	8	6 1/2	5 3/4	3 1/4	4 3/4
18	28	2 3/8	21	21	24	1 1/4	24 3/4	7 1/2	8 1/4	6 3/4	6 1/4	3 1/2	5 1/8
20	30 1/2	2 1/2	23	23 1/8	24	1 1/4	27	8	8 3/4	7	6 3/8	3 3/4	5 1/2
22	33	2 5/8	25 1/4	25 1/4	24	1 1/2	29 1/4	8 3/4	9 3/4	7 1/2	6 1/2	4	5 3/4
24	36	2 3/4	27 1/4	27 5/8	24	1 1/2	32	9	10	7 3/4	6 5/8	4 3/16	6
26	38 1/4	3 1/8	29 1/2	28 3/8	28	1 5/8	34 1/2	10	11	8 3/4	7 1/4	7 1/4	—
28	40 3/4	3 3/8	31 1/2	30 1/2	28	1 5/8	37	10 1/2	11 1/2	9 1/4	7 3/4	7 3/4	—
30	43	3 5/8	33 3/4	32 9/16	28	1 3/4	39 1/4	11 1/4	12 1/4	10	8 1/4	8 1/4	—
32	45 1/4	3 7/8	36	34 11/16	28	1 7/8	41 1/2	12	13 1/4	10 1/2	8 3/4	8 3/4	—
34	47 1/2	4	38	36 7/8	28	1 7/8	43 1/2	12 1/4	13 1/2	10 3/4	9 1/8	9 1/8	—
36	50	4 1/8	40 1/4	39	32	2	46	12 3/4	14	11 1/4	9 1/2	9 1/2	—

OVERVIEW

WATTCO™ square or round flange heaters are the perfect energy efficient solution for heating liquids in open tanks and low-pressure vessels. Suitable for constrained areas, square and round flanges are made of compact elements that are easily installed by tightening a series of bolts. Changing the assembly is simple:

- Disconnect the power
- Unbolt the flange
- Replace it with another heater

FEATURES

KEY FEATURES

Replacement Boiler Flange Heaters – TYPE FL

- Square flange
- Round flange

SELECTING

WATTCO™ FLANGE HEATER WITH SQUARE FLANGES

This section will help you select the most suitable WATTCO™ replacement boiler flange heater with square flanges that meets the requirements of your application. Please call us at 1.800.4WATTCO (1.800.492.8826) for further assistance.

CAUTION

Low water levels in the boiler or excessive scale build-up on the heating elements cause most boiler heater failures and both have to be taken into account should several heaters fail simultaneously.

It is recommended to contact a water treatment specialist in your area to examine or clean your system before installing any replacement parts.

2 1/2" SQUARE FLANGE

WHEN ORDERING, PLEASE SPECIFY:

- quantity
- catalogue number
- flange size and material
- voltage/wattage
- phase
- steam* or water boiler replacement
- description of the heater if no catalogue or part number matched your unit

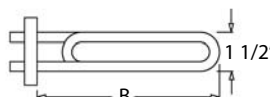
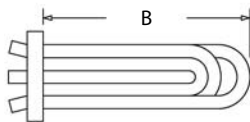

TYPE 1

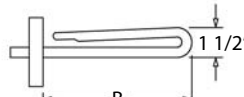

TYPE 2

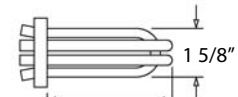

TYPE 3

* **WARNING:** When placing an order, please specify if you are requesting a replacement unit/part for a **steam application**. Special recommendations will be given.

BENEFITS

- Energy efficient
- Broad variety of sizes for different applications
- Compact
- Superior seal between flanges
- Moisture and contaminant resistant
- Easy to install
- Easy to maintain
- Designed and built for safety



APPLICATIONS

- Water
- Boiler equipment
- Open storage tanks containing:
 - o Degreasing solvents
 - o Fuel oils
 - o Heat-transfer fluids
 - o Caustic solutions



2 1/2" SQUARE STEEL FLANGE (CUSTOM-DESIGNED)

The following types of heater configurations are available upon request:

WHEN ORDERING, PLEASE SPECIFY:

- type 1, 2 or 3
- 'B' dimension
- voltage / wattage
- phase
- any additional drawings if available

For other custom units, please specify:

- application
- flange size, dimensions, and material
- sheath material and diameter
- number of elements
- quantity
- options
- bolt pattern, if not standard
- no-heat section below the flange
- immersed length

See figures below.

Available replacements:

3 5/8" x 9 5/8" FLANGE
4 1/2" SQUARE FLANGE

5 1/2" SQUARE FLANGE
6 3/4" SQUARE FLANGE

REPLACEMENT BOILER HEATERS WITH ROUND FLANGES

SELECTING

WATTCO™ FLANGE HEATER WITH ROUND FLANGES

This section will help you select the most suitable WATTCO™ replacement boiler flange heater with round flanges that meets the requirements of your application. Please call us at 1.800.4WATTCO (1.800.492.8826) for further assistance.

CAUTION

Low water levels in the boiler or excessive scale build-up on the heating elements cause most boiler heater failures and both have to be taken into account should several heaters fail simultaneously.

It is recommended to contact a water treatment specialist in your area to examine or clean your system before installing any replacement parts.



**TABLE 1
6" - SPECIAL FLANGE - BOILERS**

KW	STD. VOLTAGES	CAT. NO.	WT. - LBS (KG)
15	208, 240, 416, 480, 600	FLIB9116415X10	31 (14)
15	"	FLIB9116815X10	31 (14)
30	"	FLIB9117130X10	40 (18)
30	"	FLIB9118130X10	40 (18)
30	"	FLIB9118230X10	40 (18)
36	"	FLIB9118236X10	40 (18)
37.5	"	FLIB9118237X10	40 (18)
45	"	FLIB9118245X10	44 (20)
45	"	FLIB9118345X10	44 (20)
45	"	FLIB9118445X10	44 (20)
60	"	FLIB9118560X10	48 (22)
60	"	FLIB9118660X10	48 (22)
60	"	FLIB9118760X10	48 (22)
72	"	FLIB9118772X10	53 (24)
75	"	FLIB9118775X10	53 (24)
75	"	FLIB9118875X10	53 (24)
75	"	FLIB9118975X10	53 (24)
90	"	FLIB9118990X10	59 (27)
90	"	FLIB9119090X10	59 (27)
90	"	FLIB9119190X10	59 (27)
108	"	FLIB9120108X10	66 (30)
112.5	"	FLIB9120112X10	66 (30)
125	"	FLIB9120125X10	70 (32)
135	"	FLIB9120135X10	70 (32)
145	"	FLIB9120145X10	70 (32)
150	"	FLIB9120150X10	70 (32)
187.5	"	FLIB9120187X10	79 (36)
225	"	FLIB9120225X10	79 (36)

**TABLE 2
6" - 150 LB. FLANGE - BOILERS**

KW	STD. VOLTAGES	CAT. NO.	WT. - LBS (KG)
15	208, 240, 416, 480, 600	FLIB9216415X10	35 (16)
30	"	FLIB9216830X10	44 (20)
30	"	FLIB9217130X10	44 (20)
38	"	FLIB9218138X10	44 (20)
45	"	FLIB9218245X10	48 (22)
45	"	FLIB9218245X10	48 (22)
60	"	FLIB9218260X10	53 (24)
75	"	FLIB9218275X10	57 (26)
75	"	FLIB9218375X10	57 (26)
90	"	FLIB9218490X10	66 (30)
90	"	FLIB9218590X10	66 (30)
100	"	FLIB9218100X10	73 (33)
135	"	FLIB9218135X10	73 (33)

WHEN ORDERING, PLEASE SPECIFY:

- quantity
- catalogue number
- flange size and material
- voltage/wattage
- phase
- steam* or water boiler replacement
- description of the heater if no catalogue or part number matched your unit
- drawings

* **WARNING:** When placing an order, please specify if you are requesting a replacement unit/part for a **steam application**. Special recommendations will be given.

REPLACEMENT BOILER HEATERS WITH ROUND FLANGES

SELECTING

WATTCO™ FLANGE HEATER WITH ROUND FLANGES

This section will help you select the most suitable WATTCO™ replacement boiler flange heater with round flanges that meets the requirements of your application. Please call us at 1.800.4WATTCO (1.800.492.8826) for further assistance.

CAUTION

Low water levels in the boiler or excessive scale build-up on the heating elements cause most boiler heater failures and both have to be taken into account should several heaters fail simultaneously.

It is recommended to contact a water treatment specialist in your area to examine or clean your system before installing any replacement parts.



TABLE 3
6" - 300 LB. FLANGE - BOILERS

KW	STD. VOLTAGES	CAT. NO.	WT. - LBS (KG)
116.7	208, 240, 416, 480, 600	FLIB9236116X10	60 (30)
150	"	FLIB9236150X10	70 (32)
175.1	"	FLIB9236175X10	75 (34)

TABLE 4
8" - 150 LB. FLANGE - BOILERS

KW	STD. VOLTAGES	CAT. NO.	WT. - LBS (KG)
36	208, 240, 416, 480, 600	FLIB9236036X12	79 (36)
45	"	FLIB9236045X12	84 (38)
72	"	FLIB9236072X12	88 (40)
90	"	FLIB9236090X12	92 (42)
108	"	FLIB9236108X12	92 (42)
135	"	FLIB9236135X12	99 (45)
144	"	FLIB9236144X12	99 (45)
180	"	FLIB9236180X12	106 (48)
180	"	FLIB9237180X12	106 (48)
216	"	FLIB9236216X12	112 (51)
225	"	FLIB9236225X12	119 (54)
270	"	FLIB9236270X12	139 (63)
270	"	FLIB9236270X12	139 (63)

WHEN ORDERING, PLEASE SPECIFY:

- quantity, catalogue number, flange size and material, voltage/wattage, phase, steam* or water boiler replacement, description of the heater if no catalogue or part number matched your unit.

* **WARNING:** When placing an order, please specify if you are requesting a replacement unit/part for a **steam application**. Special recommendations will be given.



CUSTOM HEATERS WITH ROUND FLANGES

WHEN ORDERING A CUSTOM ROUND FLANGE BOILER REPLACEMENT, PLEASE SPECIFY:

- type A, B, C, D dimensions, voltage/wattage, phase, number of elements, number of circuits

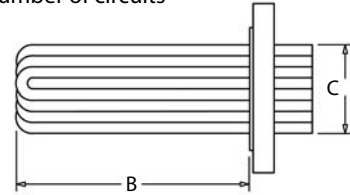

FOR OTHER CUSTOM UNITS, PLEASE SPECIFY:

- application
- flange size, dimensions, and material
- sheath material and diameter
- quantity
- options
- bolt pattern, if not standard
- no-heat section below the flange
- immersed length

TYPE A

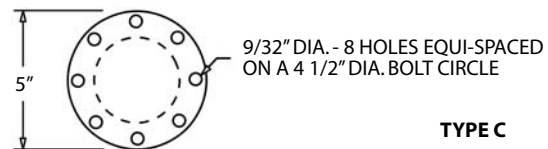

TYPE C

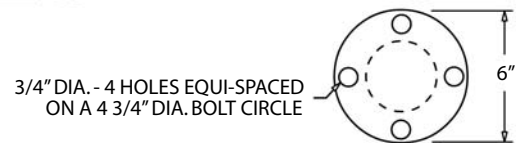

TYPE B

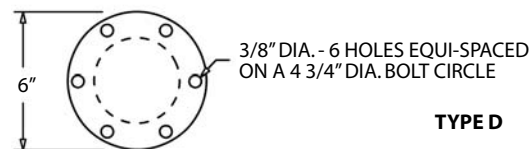

TYPE D

